

REPLACEMENT OF PACKING STUFF WITH MECHANICAL SEAL

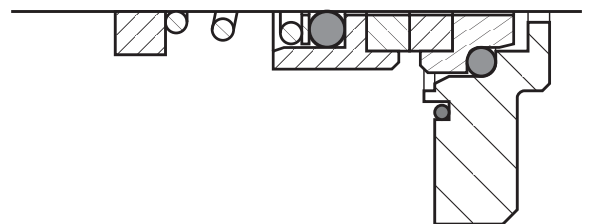

Type D700 with bridle

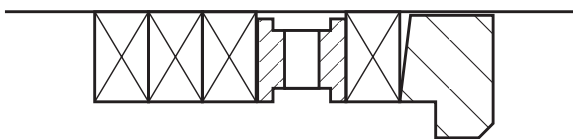
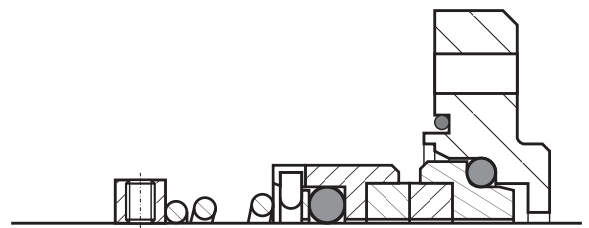
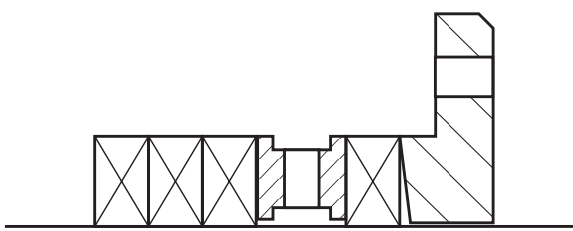
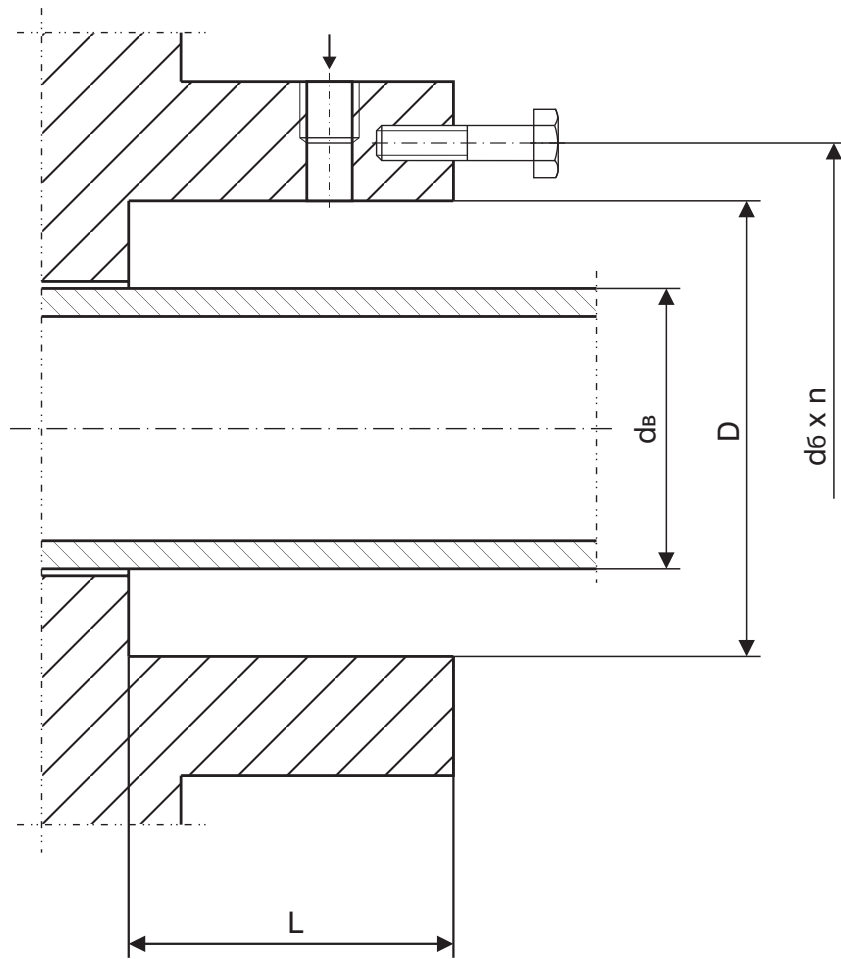
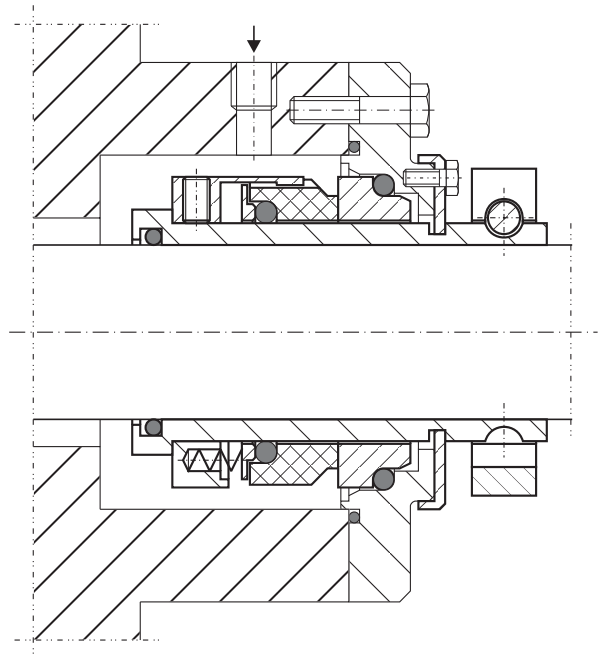
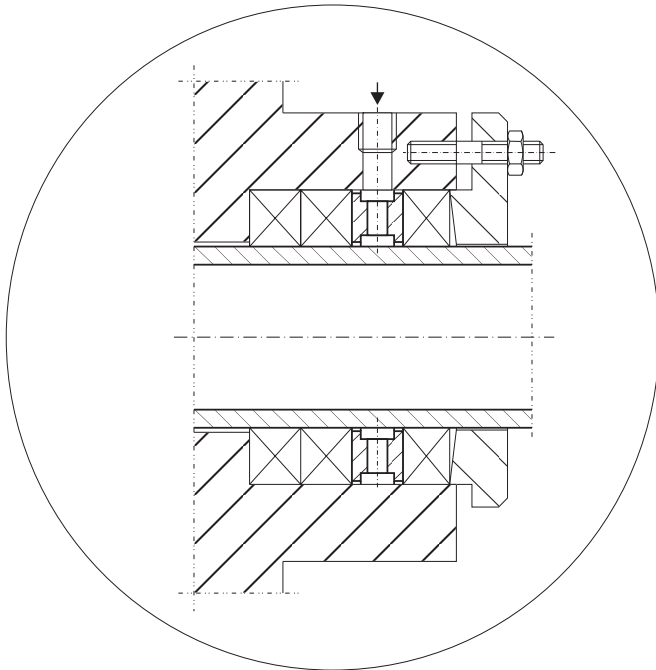

Type D720

